



Updates in EU Conformity Assessment

MIC MRA International Workshop
10-11 March 2022

Speaker

Holger Bentje
Chairman REDCA



<http://www.redca.eu/>





Content

- Update RED Harmonised Standards
- Caller Location in Emergency Communications
- Cybersecurity
- Common Charger
- Technical Guidance Notes (TGNs)
- REDCA Information

RED Harmonised Standards



Changes in the publication of HS

- New listings of Harmonised Standards (HS) are via a formal European Commission Implementing Decision.
- Published in the L (legislation) series of the EU Official Journal.
- Harmonised Standards shall specify precise performance criteria, technical specifications and tests (legal certainty).
- Equipment not covered by a specific part of an HS cannot benefit from “Presumption of Conformity”.
- The Commission provides a summary list. The list reproduces information already published in the OJ L or C. [Radio equipment \(europa.eu\)](https://eur-lex.europa.eu/eli/reg/2017/1132/oj)

RED Harmonised Standards

COMMISSION IMPLEMENTING DECISION (EU) 2021/1196 of 19 July 2021



Harmonised standards in Annex I

- **EN 303 204 V3.1.1** Fixed Short Range Devices (SRD) in data networks; Radio equipment to be used in the 870 MHz to 876 MHz frequency range with power levels ranging up to 500mW e.r.p.; Harmonised Standard for access to the radio spectrum
- **EN 303 276 V1.2.1** Maritime Broadband Radiolink operating within the bands 5 852 MHz to 5 872 MHz and/or 5 880 MHz to 5 900 MHz for ships and off-shore installations engaged in coordinated activities; Harmonised Standard for access to radio spectrum’.

satisfy the essential requirements which they aim to cover and which are set out in Directive 2014/53/EU.

RED Harmonised Standards

COMMISSION IMPLEMENTING DECISION (EU) 2021/1196 of 19 July 2021



Harmonised standards with restrictions in Annex II (1/2)

- **EN 302 066 V2.2.1** Short Range Devices (SRD); Ground- and Wall- Probing Radio determination (GPR/WPR) devices; Harmonised Standard for access to radio spectrum
Notice: Compliance with this harmonised standard shall not confer a presumption of conformity with the essential requirement set out in Article 3(2) of Directive 2014/53/EU if any of the following is applied:
 - in the ninth paragraph of clause 6.2.5 of that standard, the sentence ‘For the emission measurements, a combination of bicones and log periodic dipole array antennas (commonly termed “log periodics”) could also be used to cover the entire 30 MHz to 1 000 MHz band’;
 - the tenth paragraph of clause 6.2.5 of that standard;
 - the eleventh paragraph of clause 6.2.5 of that standard.
- **EN 302 208 V3.3.1** Radio Frequency Identification Equipment operating in the band 865 MHz to 868 MHz with power levels up to 2 W and in the band 915 MHz to 921 MHz with power levels up to 4 W; Harmonised Standard for access to radio spectrum
Notice: For the purposes of presumption of conformity with the essential requirement set out in Article 3(2) of Directive 2014/53/EU, in Table 2 of this harmonised standard, the limit ‘692 MHz’ is replaced by the following: ‘694 MHz.’

RED Harmonised Standards

COMMISSION IMPLEMENTING DECISION (EU) 2021/1196 of 19 July 2021



Harmonised standards in Annex II (2/2)

- **EN 302 609 V2.2.1** Short Range Devices (SRD); Radio equipment for Euroloop communication systems; Harmonised Standard for access to radio spectrum *Notice:* For the purposes of presumption of conformity with the essential requirement set out in Article 3(2) of Directive 2014/53/EU:
 - in the second row of Table 3 of this harmonised standard, the limit ‘29 090 MHz’ shall be read as ‘27 090 MHz’;
 - in the third row of Table 3 of this harmonised standard, the limit ‘29 100 MHz’, shall be read as ‘27 100 MHz.’
- **EN 303 258 V1.1.1** Wireless Industrial Applications (WIA); Equipment operating in the 5 725 MHz to 5 875 MHz frequency range with power levels ranging up to 400 mW; Harmonised Standard for access to radio spectrum *Notice:* Compliance with this harmonised standard shall not confer a presumption of conformity with the essential requirement set out in Article 3(2) of Directive 2014/53/EU, in case that the appropriate test methods are not carried out in order to demonstrate compliance with clauses 4.2.8.2, 4.2.9.3 and 4.2.10.3 of this harmonised standard.’

have been published in the EU-OJ **with restrictions.**

They do not cover a presumption of conformity to the essential requirements.

RED Harmonised Standards

COMMISSION IMPLEMENTING DECISION (EU) 2021/1196 of 19 July 2021



Harmonised standards in Annex III

- **EN 302 066-2 V1.2.1** Date of withdrawal 20 January 2023
- **EN 302 208 V3.1.1** Date of withdrawal 20 January 2023
- **EN 302 609 V2.1.1** Date of withdrawal 20 January 2023
- **EN 303 204 V2.1.2** Date of withdrawal 20 January 2023
- **EN 303 276 V1.1.1** Date of withdrawal 20 January 2023

have been published in the EU-OJ **with a date of withdrawal.**

They will **cease to** give presumption of conformity to the essential requirements for Radio equipment placed on the market after the date of withdrawal.

RED Harmonised Standards

Use of Non-harmonized standards



REMINDER from the last Workshop

- If a manufacturer uses non-harmonized standards as part of the conformity assessment, a comprehensive justification is required in the risk assessment as to why the respective essential requirements are met.
- RED Annex V (d) on Technical Documentation:
*...and, where those harmonised standards have not been applied, **descriptions of the solutions adopted to meet the essential requirements set out in Article 3, including a list of other relevant technical specifications applied. In the event of partly applied harmonised standards, the technical documentation shall specify the parts which have been applied***
- This requirements must be addressed in the Risk Assessment



Content

- Update RED Harmonised Standards
- **Caller Location in Emergency Communications**
- Cybersecurity
- Common Charger
- Technical Guidance Notes (TGNs)
- REDCA Information

Article 3(3) Requirements



Pursuant to Article 3(3) of Directive 2014/53/EU, the European Commission is to specify which categories or classes of radio equipment are concerned by each of the essential requirements set out in points (a) to (i) of the first subparagraph of Article 3(3) of the RED.

Article 3(3)

Conformity Assessment Procedures

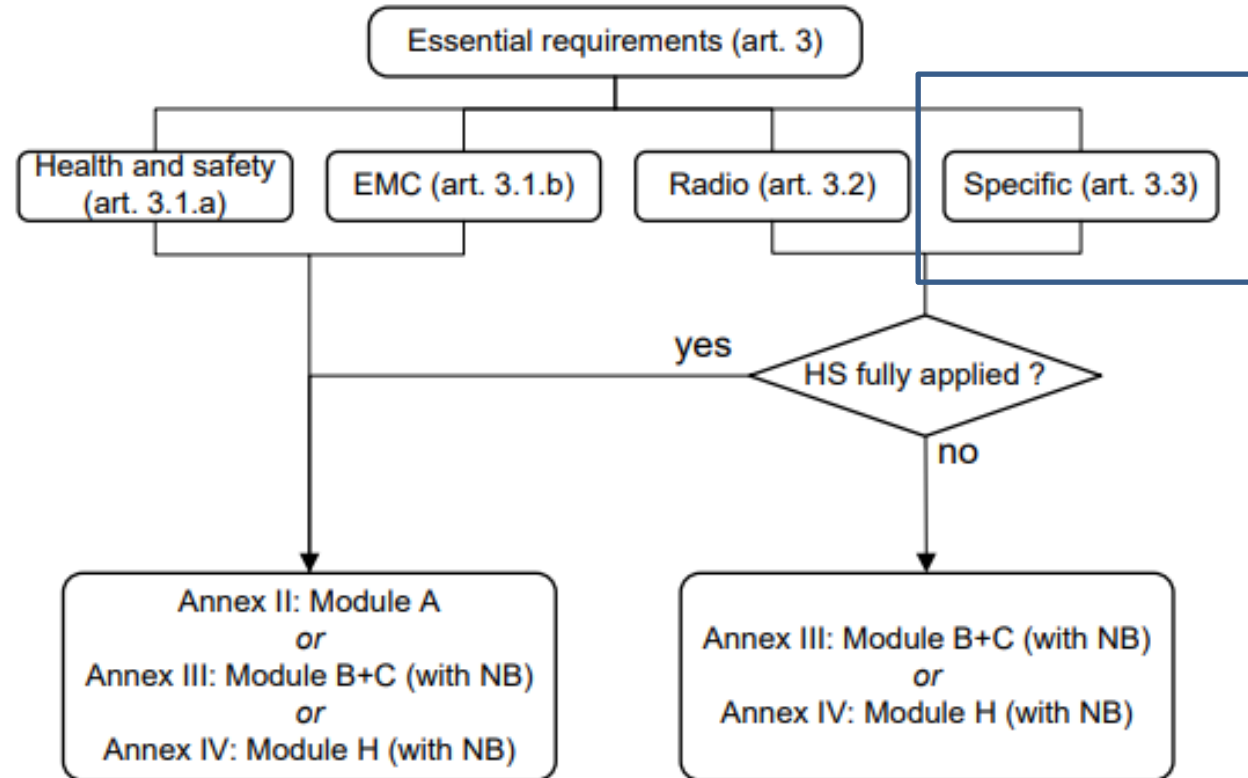

Source: Guide to the Radio Equipment Directive 2014/53/EU

Article 3(3)(g)

Delegated Regulation 2019/320



- The Delegated Regulation 2019/320, adopted on 12 December 2018, aims at making emergency communications from mobile devices more effective, notably by improving the accuracy of the caller location.
- Smartphones have a key role in receiving and processing the electromagnetic signals, including Global Navigation Satellite System (GNSS) and Wireless Local Area Network (WLAN) derived, on the basis of which the location of the caller may be established.

Article 3(3)(g)

Delegated Regulation 2019/320



[Commission Delegated Regulation \(EU\) 2019/320](#) of 12 December 2018 with regard to the application of the essential requirements referred to in Article 3(3)(g) of Directive 2014/53/EU in order to ensure caller location in emergency communications from mobile devices.

- Smartphone compliance is **mandatory from 17 March 2022**.
- ETSI has received a standardisation request from the Commission. The request was not accepted in December 2020.
- There is no harmonized standard available at this moment.

Article 3(3)(g)

Delegated Regulation Guidelines



The European Commission developed a guideline to support RED Notified Bodies in April 2021

<https://ec.europa.eu/docsroom/documents/45707?locale=en>



GUIDELINES FOR
COMPLIANCE WITH
DELEGATED REGULATION
(EU) 2019/320

European Commission, April 2021

Article 3(3)(g)

Delegated Regulation Guidelines



The requirements supporting the compliance with Delegated Regulation 2019/320 were divided into four thematic groups:

1. Compatibility and interoperability with the Galileo system,
2. Availability of GNSS raw measurements,
3. Processing and making available for transmission of the data referred to in Article 1(2) of Delegated Regulation (EU) 2019/320,
4. Use of a wireless local area network for positioning (field test).

Article 3(3)(g)

Delegated Regulation Guidelines



Three test sections in the
Guideline

- Galileo Compliance, Section 5
- Advanced Mobile Location (AML) Compliance, Section 6
- WLAN location compliance (field test in various real locations), Section 7

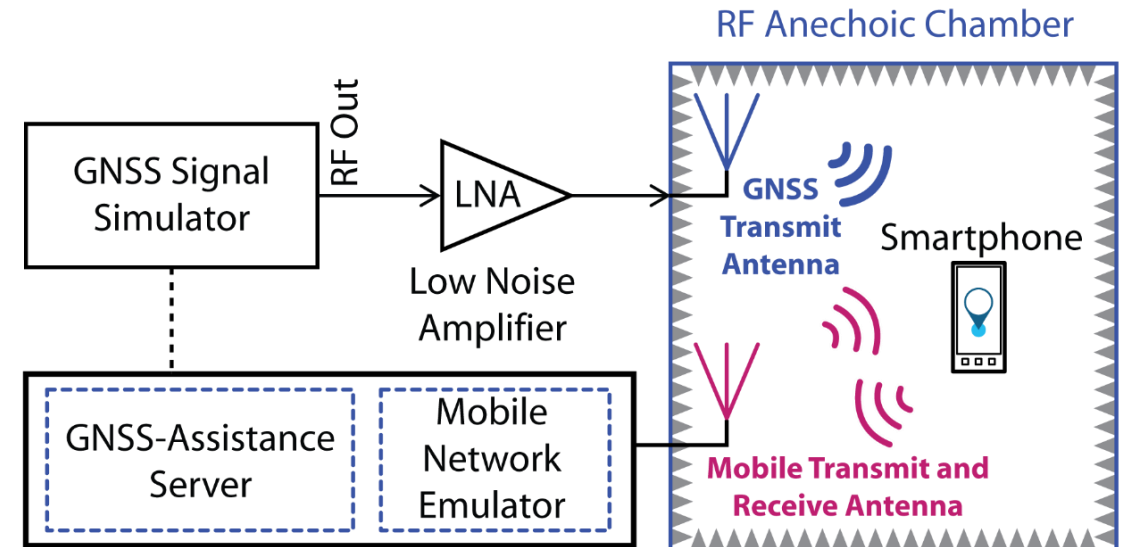



Content

- Update RED Harmonised Standards
- Caller Location in Emergency Communications
- **Cybersecurity**
- Common Charger
- Technical Guidance Notes (TGNs)
- REDCA Information

Article 3(3) Requirements

RED and Cybersecurity



Points (d), (e) and (f) of Article 3(3) of Directive 2014/53/EU aim at ensuring that the radio equipment concerned protect the user from elements of cybersecurity risks.

- Point (d) provides that radio equipment does not harm the network or its functioning nor misuse network resources, thereby causing an unacceptable degradation of service.
- Point (e) provides that radio equipment incorporates safeguards to ensure that the personal data and privacy of the user and of the subscriber are protected.
- Point (f) provides that radio equipment supports certain features ensuring protection from fraud.

RED Delegated Act Articles 3(3)(d)(e)(f)



Cybersecurity and DA

- The Delegated Act (DA) to the RED actively implements the essential requirements under Article 3(3) to address security concerns for products.
- Voluntary harmonised standards should help to ensure a high level of protection of the network, personal data and privacy, and protection against fraud of individuals throughout the Union, thus promoting the free movement of certain radio equipment in the Union.
- The harmonised standards should contain detailed technical specifications, including appropriate test methods, for the essential requirements referred to in points (d), (e) and (f) of Article 3(3).

Delegated Act on Cybersecurity



The COMMISSION DELEGATED REGULATION (EU) 2022/30 of 29 October 2021 was published in the Official Journal of the European Union on 12 January 2022.

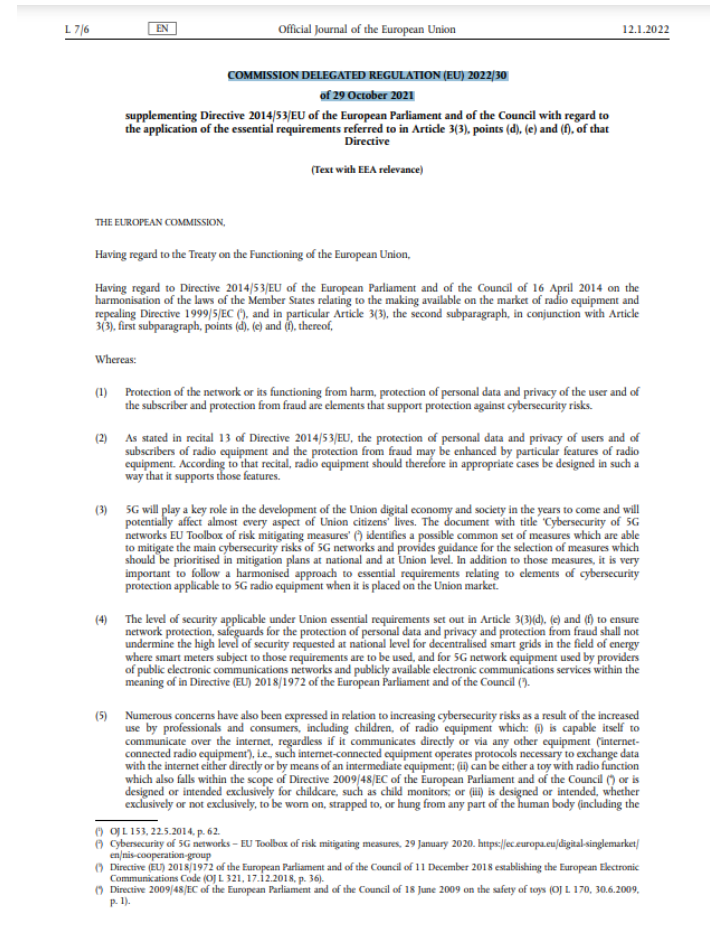

DELEGATED REGULATION (EU) 2022/30

Article 1(1)



The network protection requirements apply to any radio equipment that can itself communicate via the Internet, regardless of whether it communicates directly or via other equipment ("radio equipment with an Internet connection").

DELEGATED REGULATION (EU) 2022/30



Article 1(2), 1 of 2

The personal data protection and privacy requirements apply to the following radio equipment:

- a) Radio equipment connected to the Internet, unless specified in b), c), or d);
- b) Radio equipment designed or intended solely for childcare;
- c) Radio equipment covered by Directive 2009/48/EC (safety of toys);

DELEGATED REGULATION (EU) 2022/30

Article 1(2), 2 of 2



(d) Radio equipment designed or intended to be worn, strapped, or hung from any of the following:

- (i) any part of the human body, including the head, neck, trunk, arms, hands, legs and feet;
- (ii) any clothing, including headwear, hand wear and footwear, which is worn by human beings.

DELEGATED REGULATION (EU) 2022/30



Article 1(3)

Fraud protection requirements apply to any wireless device connected to the Internet if that device allows the owner or user to transfer

- money,
- monetary values or
- virtual currencies as defined in Article 2(d) of Directive 2019/713/EU (combating fraud and counterfeiting of non-cash means of payment).

DELEGATED REGULATION (EU) 2022/30



Article 2, 1 of 2

The requirements referred to in points (d), (e) and (f) of Article 3(3) shall not apply to radio equipment to which any of the following Union legislation also applies:

- Regulation (EU) 2017/745 (medical devices);
- Regulation (EU) 2017/746 (in vitro diagnostic medical devices).

DELEGATED REGULATION (EU) 2022/30



Article 2, 2 of 2

The requirements referred to in points (e)(privacy) and (f)(fraud) of Article 3(3) shall not apply to radio equipment to which any of the following Union legislation also applies:

- Regulation (EU) 2018/1139 (civil aviation);
- Regulation (EU) 2019/2144 (type-approval of vehicles);
- Directive (EU) 2019/520 (electronic toll collection systems).

DELEGATED REGULATION (EU) 2022/30

Article 3



The DELEGATED REGULATION (EU) 2022/30 on Cybersecurity shall apply from **1 August 2024**.

Next Steps:

Draft Standardisation Request to ESOs



- The European Commission has published possible future standardization request to European standardization organisations (ESOs) on 10 January 2022
[Notification system \(europa.eu\)](https://ec.europa.eu/euro-iss/notifications-system)
- The final standardization request is expected in March 2022
- The planned processing time for the development of harmonized cybersecurity standards is 20 months
- After that, another 10 months are planned for manufacturers to implement these technical requirements into their products

Article 3.3 Cybersecurity

RED Conformity Assessment Procedures

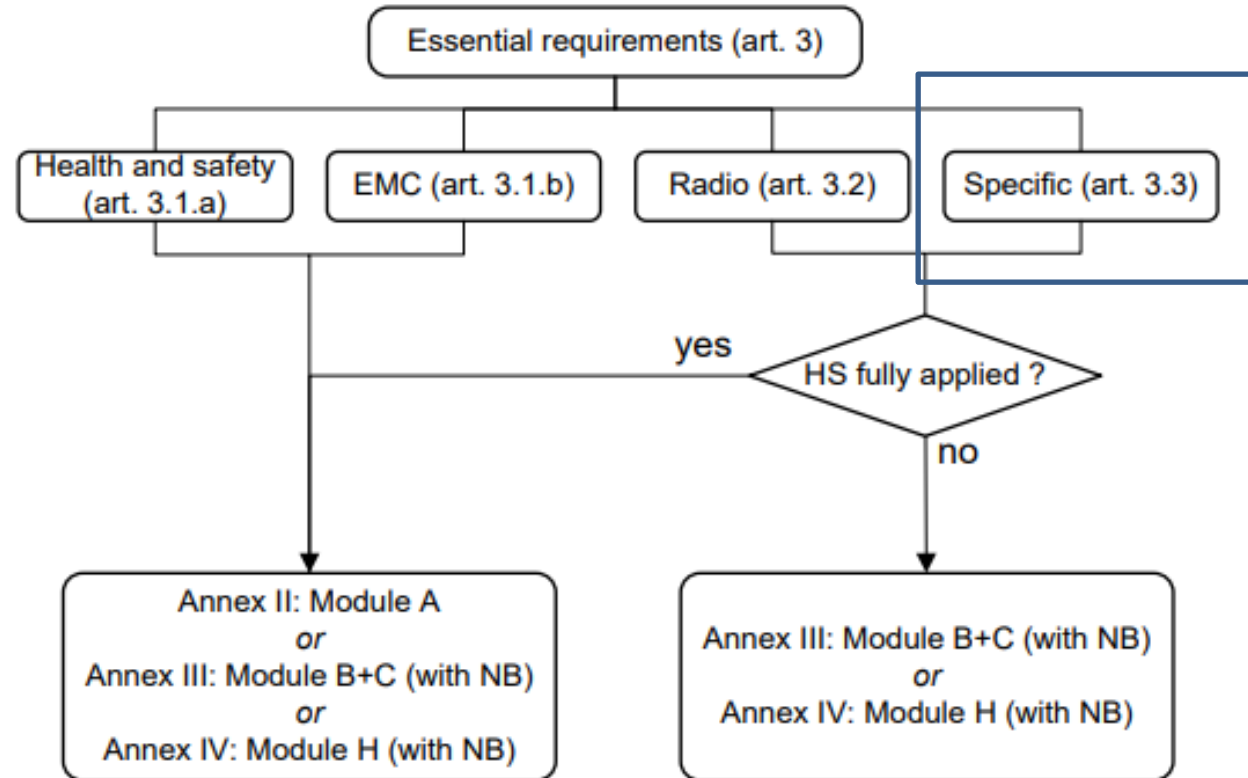

Source: Guide to the Radio Equipment Directive
2014/53/EU



Content

- Update RED Harmonised Standards
- Caller Location in Emergency Communications
- Cybersecurity
- **Common Charger**
- Technical Guidance Notes (TGNs)
- REDCA Information

Common Charger



- In January 2020, the European Parliament adopted a resolution calling for the urgent adoption of a standard for a common charger for mobile phones in order to avoid further internal market fragmentation.
- The resolution called on the European Commission to adopt a legislative measure, if necessary, to establish a common charger.

Common Charger



Reasons for a regulatory change for chargers (External Power Supply (EPS)) of mobile phones and similar devices:

- Harmonisation of the charging port and the fast charging protocol will benefit consumer (reduce the number of charging solutions).
- Introduce requirements so that end-users are not obliged to purchase a new charging device whenever they purchase a new mobile phone or similar item of radio equipment.
- Charging characteristics to be displayed will strengthen customers' knowledge of interoperability of their devices.

Proposal for an Amendment of the RED

The proposal for an amendment of the RE-Directive was published on 23 September 2021 [EUR-Lex - 52021PC0547 - EN - EUR-Lex \(europa.eu\)](#)



Brussels, 23.9.2021
COM(2021) 547 final
2021/0291 (COD)

Proposal for a

DIRECTIVE OF THE EUROPEAN PARLIAMENT AND OF THE COUNCIL
amending Directive 2014/53/EU on the harmonisation of the laws of the Member States relating to the making available on the market of radio equipment

(Text with EEA relevance)

{SEC(2021) 318 final} - {SWD(2021) 244 final} - {SWD(2021) 245 final} -
{SWD(2021) 246 final}

EN

EN

Proposal for an Amendment of the RED

Next Steps

- Adoption by the co-legislator (ordinary legislative procedure).
- Transition period of 24 months from the date of adoption will give industry time to adapt the new requirements.
- Interoperability of the EPS will be addressed by the review of the Commission's Ecodesign Regulation for energy-related products.



Content

- Update RED Harmonised Standards
- Caller Location in Emergency Communications
- Cybersecurity
- Common Charger
- **Technical Guidance Notes (TGNs)**
- REDCA Information

New Technical Guidance Notes

TGN Voting Process





- Technical Guidance Notes are developed by REDCA members.
- The development usually takes place in working groups.
- According to the approved rules of the REDCA, only RED Notified Bodies are allowed to vote on TGNs.
- TGNs are related to activities carried out by RED Notified Bodies.



New Technical Guidance Notes

TGNs on Development



- TGN 33 RED as applied to vehicles
 - The document will be published as a Reference Document (without interpretations for RED Notified Bodies)
- TGN 30 Risk analysis/assessment guide
 - Update on vote

4. Technical Guidance Notes	
<p>The REDCA publishes Technical Guidance Notes (TGNs) which are related to activities carried out by RED Notified Bodies, listed on NANDO.</p> <p>REDCA TGNs must be understood as giving general guidance to facilitate comprehension and practical implementation of the conformity assessment procedures of the Radio Equipment Directive 2014/53/EU. They have no legal force but are often considered to be State of the Art.</p> <p>REDCA TGNs related to the RED only, will appear in this section 4.</p> <p>DISCLAIMER</p> <p>No responsibility or liability can be accepted by the European Commission or the REDCA or any of its officers or members for the contents, specifications and/or advice referred to or contained in REDCA Technical Guidance Notes and/or any action taken as a result of information contained in REDCA Technical Guidance Notes.</p>	
Technical Guidance Note 01	
For Radio Equipment often referred to as Modules, noting the term "Modules" is not defined in the RED.	
(V1.2a - March 2020)	Size: 381 KB

Draft of TGN 30	
REDCA TGN 30 - RED NB Risk assessment guide - Draft update V3.1 January 2022	
For NB Voting	
<i>Accessible to RED NB only.</i>	Size: 553 KB



Content

- Update RED Harmonised Standards
- Caller Location in Emergency Communications
- Cybersecurity
- Common Charger
- Technical Guidance Notes (TGNs)
- **Annex: REDCA Information**

REDCA Information

Last and next Meeting



- The last REDCA meeting was an Online event with more than 200 participants in November 2021.
- We had very good attendance from RED Notified Bodies, laboratories and manufacturers located in North America and especially Asia.
- The next REDCA meeting will be held online on 11 May 2022.
- We hope to be able to hold our fall meeting again in presence.



Thank you for listening

Any Question?

chairman@redca.eu

c/o PHOENIX TESTLAB GmbH,
Koenigswinkel 10, 32825 Blomberg, Germany

Annex: REDCA – Who are we 1/2



- The **Radio Equipment Directive Compliance Association** provides a forum for people concerned with the compliance of radio equipment with regulations and technical standards in the European Economic Area, as well as in the Countries that have a Mutual Recognition Agreement with the EU, such as the USA, Canada, Japan, New Zealand and Australia.
- In particular formed under the requirements of the Radio Equipment Directive 2014/53/EU specifically for Article 26.11 and Article 38 for Notified Bodies (sectorial group of notified bodies).
- Members are:
 - Notified Bodies, Manufacturers,
 - Testing Laboratories & Consulting Companies
 - Member states and administrations
 - Authorities from MRA regions, etc.and they all need to follow the aims and objectives set out in the Associations Rules and Constitution.
- Annual fee for REDCA Membership is € 600.-.

Annex: REDCA – Who are we 2/2



- REDCA offers the following activities and information (and is not limited to these)
 - Rapid access to the constantly changing EU legislation/regulation and EU Standards development.
 - (Draft) material often available before general public gets it. (e.g., Guides, Implementing Acts, etc.)
 - Liaison with EU Commission, ADCO, ETSI, ECC, TCAM etc.
 - Possibility to get answers from fellow experts on specific RED (technical) questions.
 - Special Workshops.
- REDCA publishes Technical Guidance Notes and reference Doc's
 - See website <http://www.redca.eu>
- The Association meets twice a year in a location within the European Economic Area (EEA)
 - The meeting is for members only.
 - Closed session for Notified Bodies.
 - Representatives of the EU Commission, ECC, ETSI, ADCO RED and authorities from MRA countries.
 - Next meeting May 2022, probably Online.
- Has a mail server for members where they can ask questions that will trigger answers and comments from the experts within the Association
- Has a specific protected area on the CIRCABC website for all working documents.
- Maintains the Notification data base to other Notified Bodies as required by RED Annex III clause 8, on CIRCABC.